

PLISSE ŽALUZIE

PLISSE

Plisse žaluzie je textilní stínící prvek, který je nejen funkční, ale také velice dekorativní v interiéru. Látky je plisovaná (skládaná) a nabízí se zde široká škála barev.

Plisse žaluzie má velkou přednost v možnostech jejího využití jak pro svislé zastínění, tak i pro šikmé plochy a atypická okna. Uplatnění může najít například při zastínění zimních zahrad.

Také při montáži má plisse žaluzie široké možnosti a uplatnění najde například i ve střešních oknech.

Možnosti použití a zaměření plisse:

A) Do okenního výklenku:

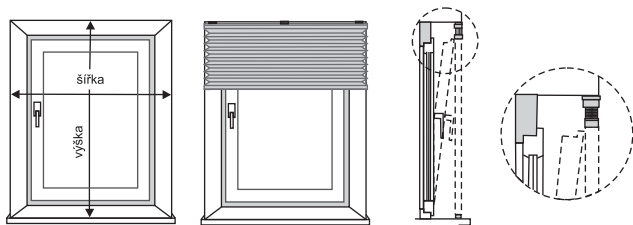

C) Na rám okna: (pozor na klíčku)

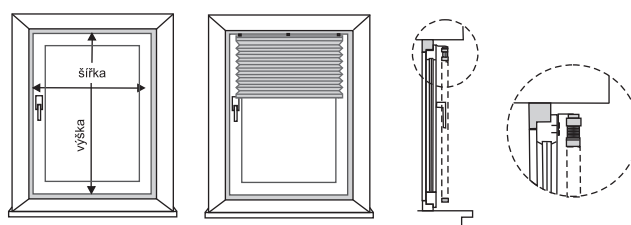

B) Přes výklenek:

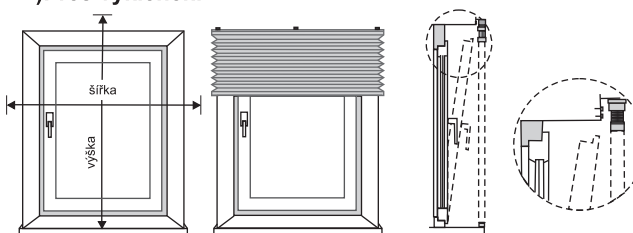

D) Ke sklu (jako žaluzie): do zasklivač lišty

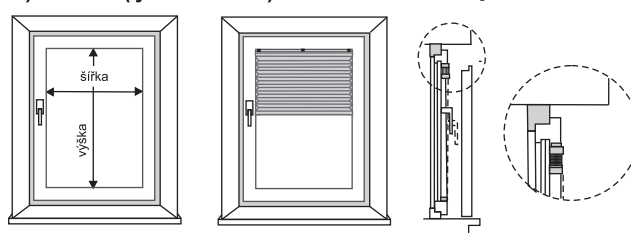

Zaměření: Plisse žaluzii zaměřte podle způsobu použití viz obr. 1 - 4. Vždy se uvádí montážní rozměry!!!

Objednání: Uvedte typ plisse, výšku, šířku, typ ovládání a v případě provázkového ovládání jeho stranu a druh látky. Plisse s úchytem a do střešního okna je vždy ve strunovém vedení. Objednávka se přijímá vždy písemně, při atypech ještě s připojeným nákresem.

Barevné provedení profilů:

RAL9001



RAL2003



RAL6021



E6 EV1



C32-BRONZ



RAL 1015



RAL2001



RAL5023



RAL7047



RAL1019



RAL1023



RAL3002



RAL5011



RAL7045



RAL8025



RAL1017



RAL4004



RAL9016



RAL7000



RAL8017



C35 ČERNÁ



Údržba:

Plisse nevyžaduje po namontování na okno žádnou velkou údržbu. Běžně jen odstraňte prach z látky, kovové a palstové prvky lze omýt vlhkou houbou. Látky lze vyčistit při silnějším zašpinění "vymáchním" ve vodě s přidávkou saponátu. Viz. obr níže.

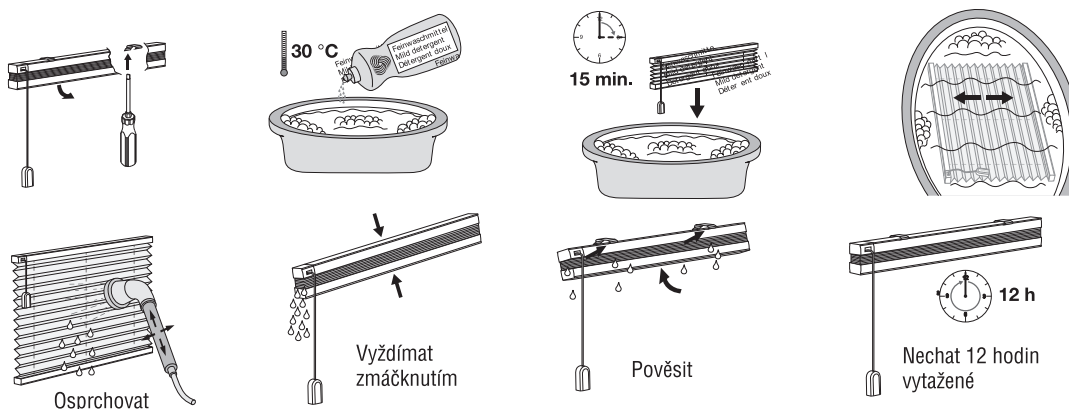

Žádáme Vás o využívání objednávkových formulářů, které prosíme zasílejte na e-mail nebo faxem.

PLISSE OVLÁDANÉ MADLEM

Objednávky se přijímají pouze písemně na objednávkovém formuláři

Výpočet ceny pro jednotlivé typy plisse

| | | max š | max v |
|------------------------|--|-------|-------|
| Ovládání madlem | XPAB210; XPAB11; cena = cena podle cenové skupiny (PG) z tabulky | 120 | 220 |
| | XPAB10; XPAB21 cena = cena podle cenové skupiny (PG) z tabulky + příplatek XOPB1 | 120 | 220 |
| | XPAB20; cena = cena podle cenové skupiny (PG) z tabulky + 2x příplatek XOPB2 | 120 | 220 |
| | XPAB31 cena = cena podle cenové skupiny (PG) z tabulky jedné + druhé látky | 120 | 220 |
| | XPAB30; XPAB32 cena = cena podle cenové skupiny (PG) z tabulky jedné + druhé látky + příplatek XOPB1 | 120 | 220 |

XPAB210

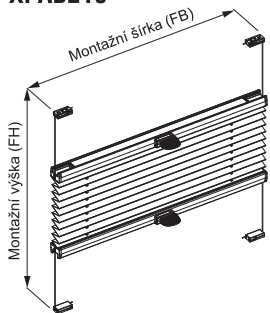

XPAB11

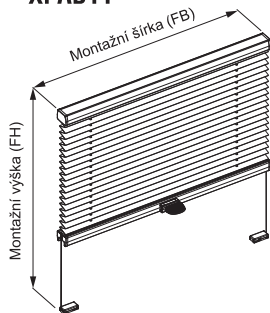

XPAB10

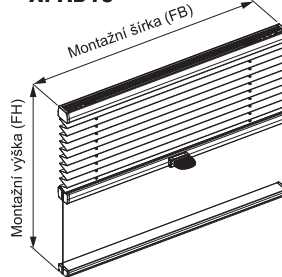

XPAB21

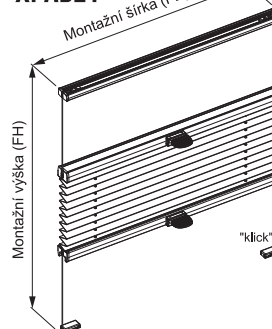

XPAB30

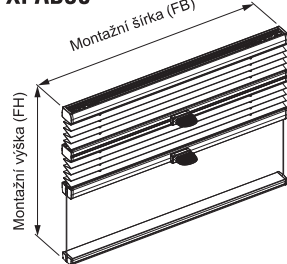

XPAB31

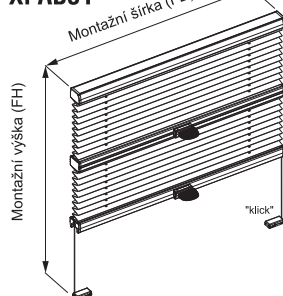

XPAB32

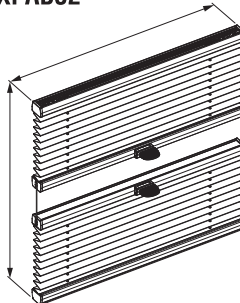

XPAB20

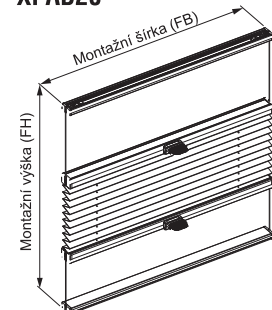

ATYPY: K ATYPICKÝM PLISSE PŘIPOJTE K OBJEDNÁVCE VŽDY NÁKRES

XPAB 68.1

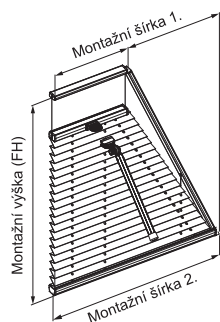

XPAB 69.1

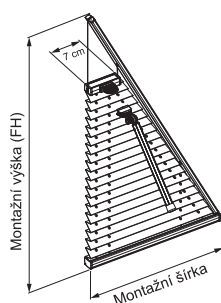

XPAB 80.1

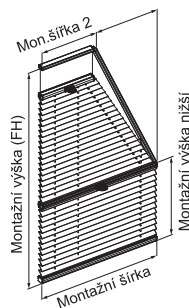

XPAB 430 A 431

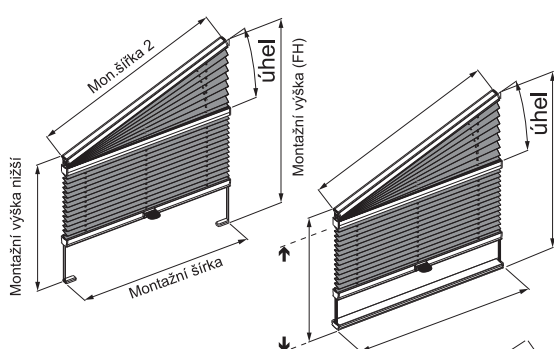

Příplatky (orientační - žádejte individuální kalkulaci)

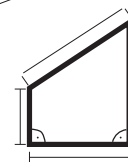
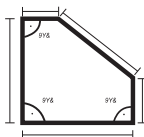
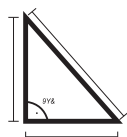
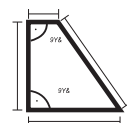

XPAB68.1 - 4960,- Kč

XPAB69.1 - 4960,- Kč

XPAB430 a 431 - 2930,- Kč

XPAB80.1 - 6540,- Kč

Pro objednání uveďte: typ, montážní rozměr, látku, barvu profilů, typ montáže

U XPAB430 a 431 je trojúhelníková část nepohyblivá

Žádáme Vás o využívání objednávkových formulářů, které prosíme zasílejte na e-mail nebo faxem.

PLISSE ŽALUZIE

PLISSE OVLÁDANÉ ŠŤÚROU

Objednávky se přijímají pouze písemně na objednávkový formulář.

Výpočet ceny pro jednotlivé typy plisse:

| Ovládání šňúrou | XPA011; XPA010 | XPA013; XPA014 | XPA031; XPA033 | max š | max v |
|-----------------|---|--|---|-------|-------|
| | cena = cena podle cenové skupiny (PG) z tabulky | cena = cena podle cenové skupiny (PG) z tabulky + Příplatek 1511,- Kč | cena = cena podle cenové skupiny (PG) z tabulky jedné + druhé látky | 220 | 250 |
| | | | | 220 | 250 |
| | | | | 120 | 220 |

XPA011
se strunovým vedením

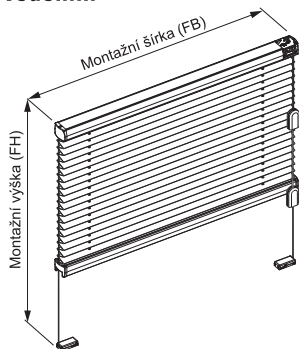

XPA010
bez strunového vedení

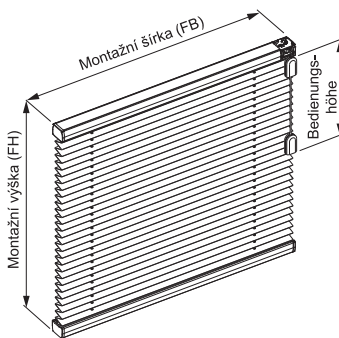

XPA014
se strunovým vedením

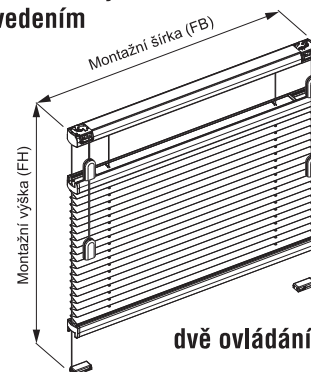

XPA013
bez strunového vedení

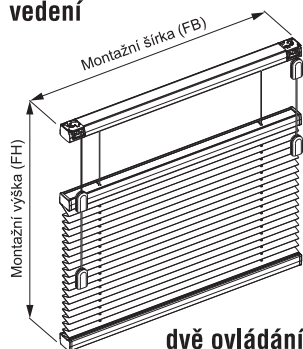

XPA031
se strunovým vedením

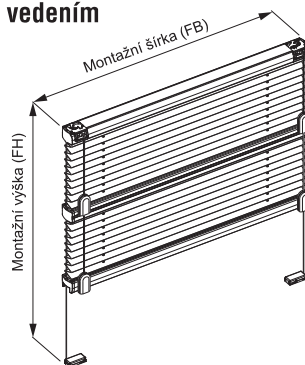

XPA033
bez strunového vedení

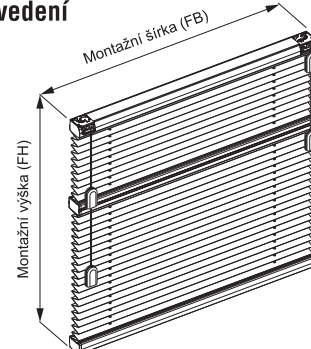

Jako úchyt pro ovládací šňúrku slouží 2ks šňúrových držácků. obr...

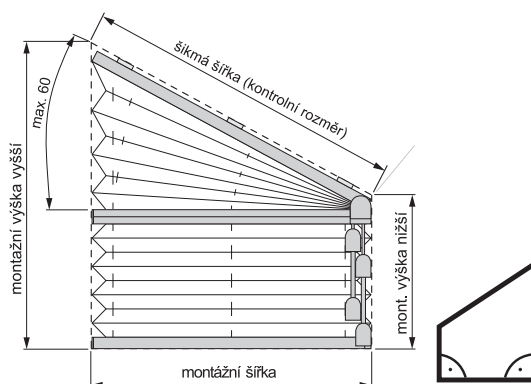

Atypy
XPA0 48
XPA0 43
XPA0 47

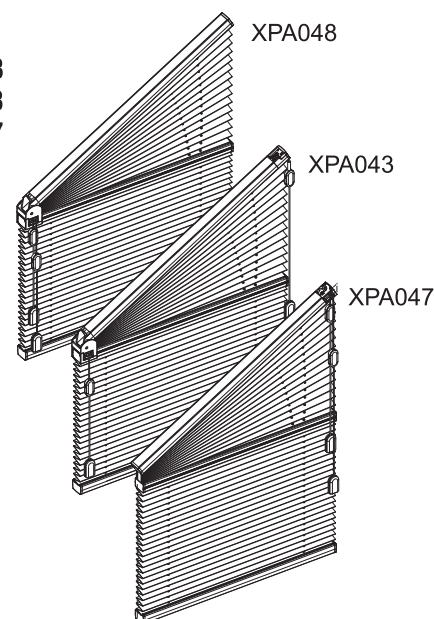

Příplatek (orientační - žádejte individuální kalkulaci)

Atypy XPA0 48, 43 a 47 - 2930,- Kč

Pro objednání uveďte: typ, montážní rozměr, látku, barvu profilů, stranu ovládání, typ montáže

Bezpečnostní držák šňúra 1ks 28,- Kč



Žádáme Vás o využívání objednávkových formulářů, které prosíme zasílejte na e-mail nebo faxem.

PLISSE DO STŘEŠNÍCH OKEN

Návod na zaměření: pokud se jedná o okno velux můžete uvést typ okna a číslo dle výrobního štítku. pro ostatní okna pak platí zaměřovací plán viz "zaměření ostatních oken A nebo B". Uvedte obě šířky GB a RB, obě výšky GH a RH a hloubku T.

Pro VELUX

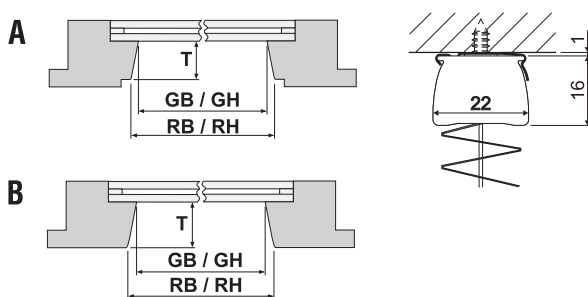
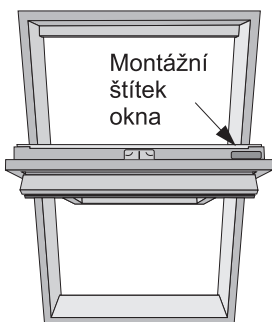

Provozní vůle

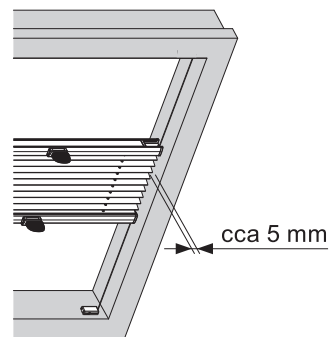

STŘEŠNÍ PLISSE

XPDB11

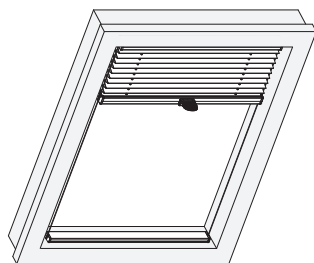

ceník + 10%

XPDB10

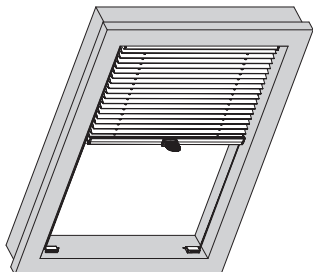

ceník + 10%
+ 350,- Kč za bm šířky

XPDB20

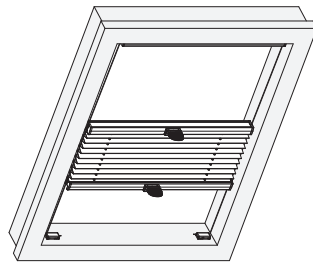

ceník + 10%
+ 350,- Kč za bm šířky

XPDB30

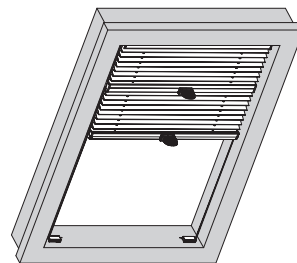

ceník jedné látky + 2 látky + 10%
+ 350,- Kč za bm šířky

Střešní plisse s překrývacími lištami.

XPDB210SF

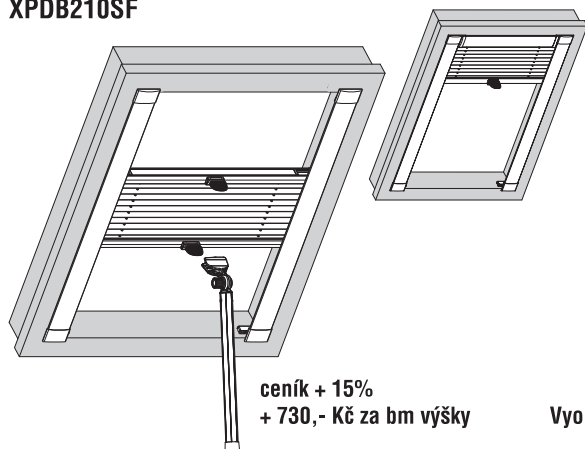

ceník + 15%
+ 730,- Kč za bm výšky

XPDB10SF

ceník + 55%

XPDB30SF

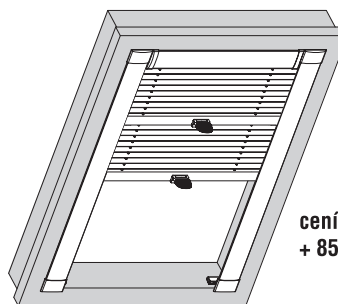

ceník jedné látky + 2 látky + 10%
+ 850,- Kč za bm výšky

Vyobrazená ovládací tyčka není součástí výrobku

Uchycení překrývacích lišt střešního plisse u úhlu 105° je lišta doplněna distanční podložkou (VELUX GGU)

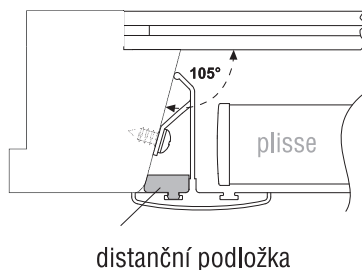
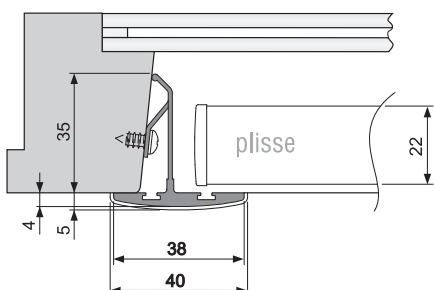

Ovládací tyčka Elox

| | | |
|--------|-------|-----------|
| 100 cm | XRP 2 | 720,- Kč |
| 150 cm | XRP 3 | 960,- Kč |
| 200 cm | XRP 4 | 1200,- Kč |
| 300 cm | XRP 6 | 1600,- Kč |

Žádáme Vás o využívání objednávkových formulářů, které prosíme zasílejte na e-mail nebo faxem.

PLISSE / ceník
PGE

| V/Š | 50 | 60 | 70 | 80 | 90 | 100 | 110 | 120 | 130 | 140 | 150 | 160 | 170 | 180 | 190 | 200 | 210 | 220 |
|-------|--------|--------|--------|--------|--------|--------|--------|--------|--------|--------|--------|--------|--------|--------|--------|--------|--------|--------|
| 80 | 1546,- | 1646,- | 1786,- | 1947,- | 2087,- | 2208,- | 2328,- | 2489,- | 2569,- | 2810,- | 2971,- | 3111,- | 3292,- | 3432,- | 3573,- | 3693,- | 3874,- | 4054,- |
| 90 | 1606,- | 1706,- | 1847,- | 2027,- | 2188,- | 2328,- | 2429,- | 2589,- | 2730,- | 2930,- | 3071,- | 3211,- | 3372,- | 3533,- | 3653,- | 3773,- | 3954,- | 4135,- |
| 100 | 1626,- | 1766,- | 1947,- | 2148,- | 2308,- | 2429,- | 2529,- | 2690,- | 2870,- | 3031,- | 3191,- | 3312,- | 3472,- | 3613,- | 3753,- | 3874,- | 4034,- | 4215,- |
| 110 | 1646,- | 1806,- | 2007,- | 2208,- | 2409,- | 2489,- | 2649,- | 2810,- | 2991,- | 3131,- | 3292,- | 3412,- | 3573,- | 3713,- | 3834,- | 3974,- | 4115,- | 4275,- |
| 120 | 1706,- | 1907,- | 2067,- | 3111,- | 2489,- | 2549,- | 2750,- | 2910,- | 3131,- | 3252,- | 3392,- | 3513,- | 3693,- | 3794,- | 3914,- | 4054,- | 4215,- | 4356,- |
| 130 | 1746,- | 1907,- | 2168,- | 2389,- | 2529,- | 2609,- | 2850,- | 2991,- | 3211,- | 3352,- | 3472,- | 3593,- | 3773,- | 3874,- | 4014,- | 4135,- | 4295,- | 4436,- |
| 140 | 1786,- | 1987,- | 2228,- | 2469,- | 2589,- | 2690,- | 2930,- | 3071,- | 3272,- | 3452,- | 3553,- | 3693,- | 3854,- | 3954,- | 4095,- | 4235,- | 4376,- | 4516,- |
| 150 | 1827,- | 2047,- | 2308,- | 2509,- | 2670,- | 2750,- | 3011,- | 3131,- | 3332,- | 3533,- | 3633,- | 3773,- | 3934,- | 4034,- | 4175,- | 4315,- | 4476,- | 4637,- |
| 160 | 1907,- | 2128,- | 2389,- | 2549,- | 2730,- | 2810,- | 3071,- | 3211,- | 3392,- | 3593,- | 3713,- | 3834,- | 4014,- | 4115,- | 4275,- | 4416,- | 4576,- | 4757,- |
| 170 | 1987,- | 2208,- | 2469,- | 2589,- | 2790,- | 2870,- | 3131,- | 3272,- | 3452,- | 3653,- | 3773,- | 3894,- | 4075,- | 4215,- | 4356,- | 4516,- | 4677,- | 4857,- |
| 180 | 2128,- | 2288,- | 2489,- | 2609,- | 2830,- | 2930,- | 3211,- | 3332,- | 3513,- | 3733,- | 3834,- | 3954,- | 4135,- | 4295,- | 4436,- | 4616,- | 4797,- | 4958,- |
| 190 | 2208,- | 2348,- | 2529,- | 2670,- | 2870,- | 2991,- | 3272,- | 3392,- | 3573,- | 3794,- | 3894,- | 4034,- | 4235,- | 4376,- | 4516,- | 4697,- | 4877,- | 5038,- |
| 200 | 2288,- | 2409,- | 2569,- | 2710,- | 2910,- | 3051,- | 3312,- | 3452,- | 3633,- | 3854,- | 3954,- | 4115,- | 4315,- | 4456,- | 4596,- | 4797,- | 4958,- | 5118,- |
| 210 | 2368,- | 2469,- | 2609,- | 2750,- | 2951,- | 3111,- | 3352,- | 3513,- | 3713,- | 3914,- | 4014,- | 4215,- | 4396,- | 4536,- | 4677,- | 4877,- | 5038,- | 5199,- |
| 220 | 2429,- | 2529,- | 2670,- | 2790,- | 2991,- | 3191,- | 3392,- | 3573,- | 3773,- | 3974,- | 4075,- | 4275,- | 4476,- | 4616,- | 4777,- | 4958,- | 5138,- | 5339,- |
| 230 | 2469,- | 2569,- | 2710,- | 2830,- | 3031,- | 3252,- | 3432,- | 3633,- | 3834,- | 4034,- | 4135,- | 4335,- | 4556,- | 4697,- | 4857,- | 5058,- | 5259,- | 5439,- |
| 240 | 2509,- | 2609,- | 2750,- | 2870,- | 3071,- | 3312,- | 3472,- | 3713,- | 3894,- | 4095,- | 4215,- | 4396,- | 4637,- | 4797,- | 4938,- | 5158,- | 5359,- | 5540,- |
| 250 | 2589,- | 2670,- | 2790,- | 2910,- | 3111,- | 3372,- | 3513,- | 3773,- | 3954,- | 4155,- | 4295,- | 4456,- | 4737,- | 4877,- | 5018,- | 5279,- | 5459,- | 5640,- |
| XOPB1 | 261,- | 281,- | 321,- | 361,- | 401,- | 422,- | 442,- | 462,- | 482,- | 502,- | 522,- | 542,- | 562,- | 582,- | 602,- | 622,- | 642,- | 662,- |

PG0

| V/Š | 50 | 60 | 70 | 80 | 90 | 100 | 110 | 120 | 130 | 140 | 150 | 160 | 170 | 180 | 190 | 200 | 210 | 220 |
|-------|--------|--------|--------|--------|--------|--------|--------|--------|--------|--------|--------|--------|--------|--------|--------|--------|--------|--------|
| 80 | 1686,- | 1786,- | 1927,- | 2067,- | 2268,- | 2429,- | 2609,- | 2830,- | 3011,- | 3292,- | 3412,- | 3553,- | 3814,- | 3914,- | 4075,- | 4175,- | 4396,- | 4596,- |
| 90 | 1706,- | 1847,- | 2027,- | 2208,- | 2389,- | 2549,- | 2750,- | 2951,- | 3171,- | 3392,- | 3533,- | 3693,- | 3934,- | 4034,- | 4215,- | 4335,- | 4536,- | 4757,- |
| 100 | 1726,- | 1907,- | 2128,- | 2308,- | 2509,- | 2730,- | 2870,- | 3071,- | 3292,- | 3492,- | 3633,- | 3814,- | 4054,- | 4155,- | 4335,- | 4476,- | 4677,- | 4897,- |
| 110 | 1766,- | 1967,- | 2208,- | 2429,- | 2670,- | 2870,- | 3011,- | 3211,- | 3412,- | 3613,- | 3794,- | 3934,- | 4175,- | 4295,- | 442,- | 4616,- | 4837,- | 5038,- |
| 120 | 1786,- | 2027,- | 2308,- | 2529,- | 2790,- | 2991,- | 3171,- | 3332,- | 3553,- | 3753,- | 3914,- | 4054,- | 4295,- | 4416,- | 4576,- | 4777,- | 4978,- | 5178,- |
| 130 | 1907,- | 2128,- | 2389,- | 2609,- | 2870,- | 3071,- | 3292,- | 3452,- | 3693,- | 3874,- | 4034,- | 4175,- | 4416,- | 4536,- | 4697,- | 4918,- | 5118,- | 5339,- |
| 140 | 1987,- | 2208,- | 2469,- | 2710,- | 2951,- | 3171,- | 3392,- | 3553,- | 3794,- | 3974,- | 4155,- | 4315,- | 4536,- | 4657,- | 4837,- | 5058,- | 5279,- | 5480,- |
| 150 | 2047,- | 2288,- | 2569,- | 2790,- | 3031,- | 3252,- | 3472,- | 3653,- | 3894,- | 4075,- | 4275,- | 4436,- | 4657,- | 4817,- | 4978,- | 5199,- | 5419,- | 5620,- |
| 160 | 2128,- | 2389,- | 2690,- | 2870,- | 3111,- | 3412,- | 3553,- | 3753,- | 3994,- | 4175,- | 4376,- | 4556,- | 4797,- | 4958,- | 5118,- | 5359,- | 5560,- | 5781,- |
| 170 | 2188,- | 2469,- | 2790,- | 2951,- | 3211,- | 3492,- | 3633,- | 3834,- | 4095,- | 4295,- | 4476,- | 4677,- | 4918,- | 5098,- | 5279,- | 5500,- | 5700,- | 5921,- |
| 180 | 2308,- | 2569,- | 2870,- | 3031,- | 3292,- | 3573,- | 3733,- | 3914,- | 4215,- | 4396,- | 4576,- | 4817,- | 5038,- | 5259,- | 5399,- | 5640,- | 5861,- | 6062,- |
| 190 | 2409,- | 2649,- | 2930,- | 3111,- | 3372,- | 3653,- | 3814,- | 3994,- | 4315,- | 4496,- | 4677,- | 4938,- | 5158,- | 5379,- | 5520,- | 5801,- | 6001,- | 6202,- |
| 200 | 2469,- | 2710,- | 2991,- | 3211,- | 3452,- | 3753,- | 3894,- | 4075,- | 4416,- | 4596,- | 4797,- | 5058,- | 5299,- | 5500,- | 5640,- | 5941,- | 6142,- | 6363,- |
| 210 | 2529,- | 2770,- | 3051,- | 3272,- | 3533,- | 3834,- | 3974,- | 4155,- | 4516,- | 4697,- | 4897,- | 5178,- | 5419,- | 5620,- | 5801,- | 6082,- | 6302,- | 6503,- |
| 220 | 2589,- | 2830,- | 3111,- | 3332,- | 3613,- | 3914,- | 4054,- | 4255,- | 4616,- | 4817,- | 4998,- | 5299,- | 5540,- | 5740,- | 5941,- | 6222,- | 6443,- | 6644,- |
| 230 | 2629,- | 2890,- | 3191,- | 3392,- | 3693,- | 3994,- | 4135,- | 4356,- | 4737,- | 4918,- | 5098,- | 5399,- | 5660,- | 5901,- | 6102,- | 6383,- | 6604,- | 6844,- |
| 240 | 2710,- | 2951,- | 3232,- | 3452,- | 3753,- | 4075,- | 4235,- | 4456,- | 4837,- | 5018,- | 5199,- | 5500,- | 5801,- | 6042,- | 6262,- | 6523,- | 6764,- | 7025,- |
| 250 | 2790,- | 3011,- | 3272,- | 3513,- | 3834,- | 4168,- | 4315,- | 4556,- | 4938,- | 5118,- | 5339,- | 5600,- | 5921,- | 6182,- | 6443,- | 6664,- | 6965,- | 7246,- |
| XOPB1 | 261,- | 281,- | 321,- | 361,- | 401,- | 422,- | 442,- | 462,- | 482,- | 502,- | 522,- | 542,- | 562,- | 582,- | 602,- | 622,- | 642,- | 662,- |

PG1

| V/Š | 50 | 60 | 70 | 80 | 90 | 100 | 110 | 120 | 130 | 140 | 150 | 160 | 170 | 180 | 190 | 200 | 210 | 220 |
|-------|--------|--------|--------|--------|--------|--------|--------|--------|--------|--------|--------|--------|--------|--------|--------|--------|--------|--------|
| 80 | 1827,- | 1987,- | 2188,- | 2368,- | 2509,- | 2710,- | 2930,- | 3171,- | 3372,- | 3653,- | 3874,- | 4054,- | 4235,- | 4476,- | 4637,- | 4797,- | 4998,- | 5178,- |
| 90 | 1907,- | 2067,- | 2268,- | 2449,- | 2670,- | 2890,- | 3131,- | 3352,- | 3573,- | 3834,- | 4034,- | 4215,- | 4436,- | 4677,- | 4817,- | 4998,- | 5178,- | 5379,- |
| 100 | 1987,- | 2148,- | 2348,- | 2589,- | 2850,- | 3091,- | 3312,- | 3533,- | 3773,- | 4014,- | 4175,- | 4396,- | 4596,- | 4837,- | 5018,- | 5178,- | 5379,- | 5580,- |
| 110 | 2108,- | 2248,- | 2429,- | 2730,- | 2991,- | 3272,- | 3513,- | 3713,- | 3934,- | 4175,- | 4335,- | 4556,- | 4777,- | 5018,- | 5199,- | 5379,- | 5580,- | 5761,- |
| 120 | 2168,- | 2328,- | 2529,- | 2890,- | 3171,- | 3452,- | 3713,- | 3874,- | 4095,- | 4356,- | 4496,- | 4717,- | 4958,- | 5178,- | 5399,- | 5580,- | 5761,- | 5961,- |
| 130 | 2248,- | 2409,- | 2609,- | 2971,- | 3272,- | 3573,- | 3894,- | 4034,- | 4235,- | 4516,- | 4657,- | 4857,- | 5118,- | 5379,- | 5600,- | 5761,- | 5981,- | 6202,- |
| 140 | 2368,- | 2509,- | 2690,- | 3091,- | 3372,- | 3713,- | 4075,- | 4195,- | 4396,- | 4677,- | 4817,- | 5018,- | 5299,- | 5580,- | 5781,- | 5961,- | 6202,- | 6423,- |
| 150 | 2429,- | 2589,- | 2790,- | 3191,- | 3492,- | 3814,- | 4215,- | 4335,- | 4536,- | 4817,- | 4998,- | 5178,- | 5480,- | 5761,- | 5981,- | 6162,- | 6403,- | 6664,- |
| 160 | 2509,- | 2670,- | 2870,- | 3292,- | 3593,- | 3914,- | 4356,- | 4436,- | 4697,- | 4978,- | 5158,- | 5359,- | 5680,- | 5961,- | 6182,- | 6343,- | 6644,- | 6945,- |
| 170 | 2589,- | 2750,- | 2951,- | 3412,- | 3713,- | 4034,- | 4476,- | 4536,- | 4817,- | 5098,- | 5319,- | 5520,- | 5881,- | 6122,- | 6363,- | 6543,- | 6885,- | 7226,- |
| 180 | 2710,- | 2850,- | 3031,- | 3513,- | 3814,- | 4135,- | 4576,- | 4657,- | 4958,- | 5239,- | 5459,- | 5680,- | 6062,- | 6302,- | 6563,- | 6724,- | 7125,- | 7507,- |
| 190 | 2750,- | 2930,- | 3151,- | 3613,- | 3914,- | 4235,- | 4697,- | 4757,- | 5098,- | 5359,- | 5620,- | 5821,- | 6262,- | 6483,- | 6744,- | 6945,- | 7346,- | 7768,- |
| 200 | 2810,- | 3011,- | 3252,- | 3733,- | 4034,- | 4356,- | 4797,- | 4857,- | 5259,- | 5480,- | 5761,- | 6001,- | 6443,- | 6664,- | 6945,- | 7145,- | 7587,- | 8049,- |
| 210 | 2910,- | 3111,- | 3352,- | 3834,- | 4135,- | 4456,- | 4897,- | 4998,- | 5399,- | 5640,- | 5941,- | 6182,- | 6624,- | 6864,- | 7145,- | 7346,- | 7828,- | 8310,- |
| 220 | 2971,- | 3191,- | 3452,- | 3914,- | 4235,- | 4556,- | 4998,- | 5098,- | 5500,- | 5781,- | 6102,- | 6343,- | 6804,- | 7045,- | 7326,- | 7567,- | 8069,- | 8550,- |
| 230 | 3051,- | 3272,- | 3533,- | 4014,- | 4356,- | 4677,- | 5078,- | 5239,- | 5640,- | 5941,- | 6282,- | 6523,- | 6965,- | 7226,- | 7527,- | 7788,- | 8310,- | 8811,- |
| 240 | 3131,- | 3352,- | 3613,- | 4095,- | 4456,- | 4757,- | 5158,- | 5339,- | 5761,- | 6082,- | 6423,- | 6684,- | 7145,- | 7406,- | 7728,- | 8009,- | 8530,- | 9072,- |
| 250 | 3232,- | 3452,- | 3713,- | 4175,- | 4556,- | 4837,- | 5259,- | 5459,- | 5901,- | 6242,- | 6583,- | 6864,- | 7306,- | 7567,- | 7908,- | 8209,- | 8771,- | 9333,- |
| XOPB1 | 261,- | 281,- | 321,- | 361,- | 401,- | 422,- | 442,- | 462,- | 482,- | 502,- | 522,- | 542,- | 562,- | 582,- | 602,- | 622,- | 642,- | 662,- |

PLISSE / ceník

PG2

| V/Š | 50 | 60 | 70 | 80 | 90 | 100 | 110 | 120 | 130 | 140 | 150 | 160 | 170 | 180 | 190 | 200 | 210 | 220 |
|-------|--------|--------|--------|--------|--------|--------|--------|--------|--------|--------|--------|--------|--------|--------|--------|---------|---------|---------|
| 80 | 1887,- | 2087,- | 2328,- | 2529,- | 2770,- | 2991,- | 3252,- | 3492,- | 3753,- | 4054,- | 4275,- | 4496,- | 4777,- | 5018,- | 5178,- | 5399,- | 5740,- | 6102,- |
| 90 | 2047,- | 2228,- | 2449,- | 2730,- | 2971,- | 3232,- | 3432,- | 3733,- | 3954,- | 4295,- | 4476,- | 4697,- | 4998,- | 5279,- | 5439,- | 5640,- | 6021,- | 6403,- |
| 100 | 2168,- | 2348,- | 2569,- | 2890,- | 3171,- | 3412,- | 3613,- | 3934,- | 4155,- | 4496,- | 4697,- | 4938,- | 5219,- | 5500,- | 5680,- | 5901,- | 6302,- | 6684,- |
| 110 | 2268,- | 2469,- | 2710,- | 3051,- | 3372,- | 3593,- | 3834,- | 4135,- | 4376,- | 4697,- | 4938,- | 5158,- | 5459,- | 5720,- | 5941,- | 6142,- | 6563,- | 6985,- |
| 120 | 2389,- | 2589,- | 2830,- | 3232,- | 3553,- | 3794,- | 4034,- | 4356,- | 4576,- | 4918,- | 5158,- | 5399,- | 5680,- | 5961,- | 6182,- | 6403,- | 6844,- | 7266,- |
| 130 | 2549,- | 2730,- | 2951,- | 3392,- | 3733,- | 3974,- | 4235,- | 4536,- | 4797,- | 5118,- | 5399,- | 5620,- | 5941,- | 6182,- | 6463,- | 6664,- | 7105,- | 7547,- |
| 140 | 2670,- | 2850,- | 3071,- | 3533,- | 3894,- | 4135,- | 4416,- | 4737,- | 4998,- | 5339,- | 5620,- | 5861,- | 6182,- | 6443,- | 6724,- | 6965,- | 7406,- | 7828,- |
| 150 | 2770,- | 2971,- | 3211,- | 3693,- | 4034,- | 4315,- | 4596,- | 4918,- | 5199,- | 5540,- | 5861,- | 6082,- | 6443,- | 6704,- | 7005,- | 7246,- | 7687,- | 8129,- |
| 160 | 2890,- | 3091,- | 3332,- | 3834,- | 4175,- | 4476,- | 4797,- | 5098,- | 5419,- | 5740,- | 6062,- | 6323,- | 6704,- | 6985,- | 7266,- | 7547,- | 7988,- | 8430,- |
| 170 | 3051,- | 3232,- | 3452,- | 3974,- | 4335,- | 4637,- | 4978,- | 5299,- | 5620,- | 5961,- | 6262,- | 6543,- | 6985,- | 7246,- | 7547,- | 7828,- | 8269,- | 8711,- |
| 180 | 3171,- | 3352,- | 3573,- | 4115,- | 4476,- | 4817,- | 5158,- | 5480,- | 5841,- | 6162,- | 6483,- | 6764,- | 7246,- | 7527,- | 7788,- | 8089,- | 8529,- | 9012,- |
| 190 | 3272,- | 3472,- | 3713,- | 4255,- | 4616,- | 4978,- | 5359,- | 5660,- | 6042,- | 6383,- | 6684,- | 7005,- | 7527,- | 7788,- | 8089,- | 8430,- | 8852,- | 9293,- |
| 200 | 3392,- | 3593,- | 3834,- | 4376,- | 4777,- | 5118,- | 5520,- | 5861,- | 6242,- | 6583,- | 6905,- | 7226,- | 7788,- | 8069,- | 8350,- | 8711,- | 9153,- | 9594,- |
| 210 | 3513,- | 3713,- | 3954,- | 4496,- | 4918,- | 5279,- | 5680,- | 6042,- | 6463,- | 6784,- | 7105,- | 7467,- | 8069,- | 8330,- | 8651,- | 9012,- | 9454,- | 9875,- |
| 220 | 3593,- | 3814,- | 4075,- | 4616,- | 5038,- | 5419,- | 5861,- | 6202,- | 6664,- | 7005,- | 7306,- | 7687,- | 8310,- | 8611,- | 8952,- | 9293,- | 9755,- | 10216,- |
| 230 | 3653,- | 3914,- | 4215,- | 4757,- | 5158,- | 5560,- | 6001,- | 6383,- | 6885,- | 7145,- | 7547,- | 7948,- | 8571,- | 8872,- | 9233,- | 9614,- | 10076,- | 10538,- |
| 240 | 3713,- | 4014,- | 4356,- | 4877,- | 5299,- | 5700,- | 6142,- | 6543,- | 7085,- | 7426,- | 7768,- | 8189,- | 8811,- | 9153,- | 9534,- | 9915,- | 10377,- | 10839,- |
| 250 | 3773,- | 4115,- | 4496,- | 4998,- | 5419,- | 5861,- | 6302,- | 6704,- | 7286,- | 7627,- | 8009,- | 8450,- | 9072,- | 9434,- | 9815,- | 10236,- | 10698,- | 11160,- |
| XOPB1 | 261,- | 281,- | 321,- | 361,- | 401,- | 422,- | 442,- | 462,- | 482,- | 502,- | 522,- | 542,- | 562,- | 582,- | 602,- | 622,- | 642,- | 662,- |

PG3

| V/Š | 50 | 60 | 70 | 80 | 90 | 100 | 110 | 120 | 130 | 140 | 150 | 160 | 170 | 180 | 190 | 200 | 210 | 220 |
|-------|--------|--------|--------|--------|--------|--------|--------|--------|--------|--------|--------|--------|--------|---------|---------|---------|---------|---------|
| 80 | 2168,- | 2368,- | 2609,- | 2890,- | 3171,- | 3412,- | 3653,- | 3974,- | 4275,- | 4456,- | 4817,- | 4918,- | 5339,- | 5540,- | 5961,- | 6383,- | 6684,- | 7005,- |
| 90 | 2248,- | 2509,- | 2810,- | 3071,- | 3332,- | 3573,- | 3874,- | 4175,- | 4476,- | 4657,- | 5018,- | 5118,- | 5560,- | 5781,- | 6182,- | 6604,- | 6945,- | 7266,- |
| 100 | 2409,- | 2670,- | 2971,- | 3252,- | 3492,- | 3753,- | 4054,- | 4396,- | 4677,- | 4877,- | 5219,- | 5359,- | 5801,- | 6001,- | 6423,- | 6824,- | 7186,- | 7567,- |
| 110 | 2529,- | 2810,- | 3131,- | 3412,- | 3693,- | 3914,- | 4255,- | 4596,- | 4897,- | 5078,- | 5439,- | 5600,- | 6042,- | 6242,- | 6664,- | 7025,- | 7447,- | 7868,- |
| 120 | 2670,- | 2951,- | 3272,- | 3573,- | 3874,- | 4095,- | 4436,- | 4817,- | 5098,- | 5299,- | 5640,- | 5861,- | 6302,- | 6503,- | 6925,- | 7226,- | 7687,- | 8149,- |
| 130 | 2830,- | 3091,- | 3392,- | 3753,- | 4054,- | 4275,- | 4616,- | 5018,- | 5319,- | 5520,- | 5861,- | 6122,- | 6543,- | 6744,- | 7166,- | 7447,- | 7968,- | 8490,- |
| 140 | 2991,- | 3232,- | 3513,- | 3914,- | 4255,- | 4436,- | 4817,- | 5199,- | 5520,- | 5740,- | 6102,- | 6403,- | 6824,- | 7025,- | 7447,- | 7707,- | 8229,- | 8751,- |
| 150 | 3111,- | 3352,- | 3633,- | 4054,- | 4416,- | 4596,- | 4998,- | 5399,- | 5720,- | 5981,- | 6343,- | 6684,- | 7085,- | 7306,- | 7728,- | 8009,- | 8530,- | 9052,- |
| 160 | 3171,- | 3452,- | 3773,- | 4175,- | 4576,- | 4777,- | 5178,- | 5580,- | 5941,- | 6202,- | 6583,- | 6985,- | 7366,- | 7607,- | 8029,- | 8290,- | 8811,- | 9333,- |
| 170 | 3252,- | 3553,- | 3894,- | 4315,- | 4757,- | 4938,- | 5379,- | 5781,- | 6142,- | 6443,- | 6844,- | 7266,- | 7627,- | 7908,- | 8310,- | 8591,- | 9112,- | 9634,- |
| 180 | 3332,- | 3653,- | 4014,- | 4436,- | 4918,- | 5118,- | 5560,- | 5961,- | 6363,- | 6664,- | 7085,- | 7587,- | 7928,- | 8189,- | 8611,- | 8872,- | 9393,- | 9915,- |
| 190 | 3452,- | 3773,- | 4135,- | 4556,- | 5078,- | 5299,- | 5740,- | 6142,- | 6563,- | 6905,- | 7346,- | 7888,- | 8209,- | 8490,- | 8912,- | 9173,- | 9695,- | 10216,- |
| 200 | 3513,- | 3874,- | 4275,- | 4677,- | 5259,- | 5459,- | 5941,- | 6343,- | 6764,- | 7125,- | 7587,- | 8169,- | 8510,- | 8771,- | 9193,- | 9474,- | 9996,- | 10517,- |
| 210 | 3593,- | 3974,- | 4396,- | 4817,- | 5399,- | 5620,- | 6122,- | 6523,- | 6985,- | 7366,- | 7828,- | 8470,- | 8791,- | 9092,- | 9514,- | 9775,- | 10317,- | 10859,- |
| 220 | 3673,- | 4075,- | 4516,- | 4938,- | 5540,- | 5801,- | 6323,- | 6704,- | 7186,- | 7587,- | 8089,- | 8731,- | 9092,- | 9393,- | 9815,- | 10096,- | 10658,- | 11220,- |
| 230 | 3834,- | 4215,- | 4637,- | 5058,- | 5680,- | 5961,- | 6503,- | 6905,- | 7406,- | 7808,- | 8330,- | 9012,- | 9373,- | 9715,- | 10156,- | 10437,- | 11019,- | 11581,- |
| 240 | 3934,- | 4335,- | 4777,- | 5178,- | 5821,- | 6122,- | 6684,- | 7085,- | 7607,- | 8049,- | 8591,- | 9273,- | 9674,- | 10036,- | 10497,- | 10798,- | 11360,- | 11922,- |
| 250 | 4054,- | 4456,- | 4897,- | 5319,- | 5941,- | 6302,- | 6885,- | 7266,- | 7808,- | 8269,- | 8831,- | 9554,- | 9976,- | 10337,- | 10819,- | 11160,- | 11722,- | 12284,- |
| XOPB1 | 261,- | 281,- | 321,- | 361,- | 401,- | 422,- | 442,- | 462,- | 482,- | 502,- | 522,- | 542,- | 562,- | 582,- | 602,- | 622,- | 642,- | 662,- |

PG4

| V/Š | 50 | 60 | 70 | 80 | 90 | 100 | 110 | 120 | 130 | 140 | 150 | 160 | 170 | 180 | 190 | 200 | 210 | 220 |
|-------|--------|--------|--------|--------|--------|--------|--------|--------|--------|--------|--------|--------|--------|---------|---------|---------|---------|---------|
| 80 | 2168,- | 2368,- | 2609,- | 2890,- | 3171,- | 3412,- | 3653,- | 3974,- | 4275,- | 4456,- | 4817,- | 4918,- | 5339,- | 5540,- | 5961,- | 6383,- | 6684,- | 7005,- |
| 90 | 2248,- | 2509,- | 2810,- | 3071,- | 3332,- | 3573,- | 3874,- | 4175,- | 4476,- | 4657,- | 5018,- | 5118,- | 5560,- | 5781,- | 6182,- | 6604,- | 6945,- | 7266,- |
| 100 | 2409,- | 2670,- | 2971,- | 3252,- | 3492,- | 3753,- | 4054,- | 4396,- | 4677,- | 4877,- | 5219,- | 5359,- | 5801,- | 6001,- | 6423,- | 6824,- | 7186,- | 7567,- |
| 110 | 2529,- | 2810,- | 3131,- | 3412,- | 3693,- | 3914,- | 4255,- | 4596,- | 4897,- | 5078,- | 5439,- | 5600,- | 6042,- | 6242,- | 6664,- | 7025,- | 7447,- | 7868,- |
| 120 | 2670,- | 2951,- | 3272,- | 3573,- | 3874,- | 4095,- | 4436,- | 4817,- | 5098,- | 5299,- | 5640,- | 5861,- | 6302,- | 6503,- | 6925,- | 7226,- | 7687,- | 8149,- |
| 130 | 2830,- | 3091,- | 3392,- | 3753,- | 4054,- | 4275,- | 4616,- | 5018,- | 5319,- | 5520,- | 5861,- | 6122,- | 6543,- | 6744,- | 7166,- | 7447,- | 7968,- | 8490,- |
| 140 | 2991,- | 3232,- | 3513,- | 3914,- | 4255,- | 4436,- | 4817,- | 5199,- | 5520,- | 5740,- | 6102,- | 6403,- | 6824,- | 7025,- | 7447,- | 7707,- | 8229,- | 8751,- |
| 150 | 3111,- | 3352,- | 3633,- | 4054,- | 4416,- | 4596,- | 4998,- | 5399,- | 5720,- | 5981,- | 6343,- | 6684,- | 7085,- | 7306,- | 7728,- | 8009,- | 8530,- | 9052,- |
| 160 | 3171,- | 3452,- | 3773,- | 4175,- | 4576,- | 4777,- | 5178,- | 5580,- | 5941,- | 6202,- | 6583,- | 6985,- | 7366,- | 7607,- | 8029,- | 8290,- | 8811,- | 9333,- |
| 170 | 3252,- | 3553,- | 3894,- | 4315,- | 4757,- | 4938,- | 5379,- | 5781,- | 6142,- | 6443,- | 6844,- | 7266,- | 7627,- | 7908,- | 8310,- | 8591,- | 9112,- | 9634,- |
| 180 | 3332,- | 3653,- | 4014,- | 4436,- | 4918,- | 5118,- | 5560,- | 5961,- | 6363,- | 6664,- | 7085,- | 7587,- | 7928,- | 8189,- | 8611,- | 8872,- | 9393,- | 9915,- |
| 190 | 3452,- | 3773,- | 4135,- | 4556,- | 5078,- | 5299,- | 5740,- | 6142,- | 6563,- | 6905,- | 7346,- | 7888,- | 8209,- | 8490,- | 8912,- | 9173,- | 9695,- | 10216,- |
| 200 | 3513,- | 3874,- | 4275,- | 4677,- | 5259,- | 5459,- | 5941,- | 6343,- | 6764,- | 7125,- | 7587,- | 8169,- | 8510,- | 8771,- | 9193,- | 9474,- | 9996,- | 10517,- |
| 210 | 3593,- | 3974,- | 4396,- | 4817,- | 5399,- | 5620,- | 6122,- | 6523,- | 6985,- | 7366,- | 7828,- | 8470,- | 8791,- | 9092,- | 9514,- | 9775,- | 10317,- | 10859,- |
| 220 | 3673,- | 4075,- | 4516,- | 4938,- | 5540,- | 5801,- | 6323,- | 6704,- | 7186,- | 7587,- | 8089,- | 8731,- | 9092,- | 9393,- | 9815,- | 10096,- | 10658,- | 11220,- |
| 230 | 3834,- | 4215,- | 4637,- | 5058,- | 5680,- | 5961,- | 6503,- | 6905,- | 7406,- | 7808,- | 8330,- | 9012,- | 9373,- | 9715,- | 10156,- | 10437,- | 11019,- | 11581,- |
| 240 | 3934,- | 4335,- | 4777,- | 5178,- | 5821,- | 6122,- | 6684,- | 7085,- | 7607,- | 8049,- | 8591,- | 9273,- | 9674,- | 10036,- | 10497,- | 10798,- | 11360,- | 11922,- |
| 250 | 4054,- | 4456,- | 4897,- | 5319,- | 5941,- | 6302,- | 6885,- | 7266,- | 7808,- | 8269,- | 8831,- | 9554,- | 9976,- | 10337,- | 10819,- | 11160,- | 11722,- | 12284,- |
| XOPB1 | 261,- | 281,- | 321,- | 361,- | 401,- | 422,- | 442,- | 462,- | 482,- | 502,- | 522,- | 542,- | 562,- | 582,- | 602,- | 622,- | 642,- | 662,- |

PLISSE / ceník

PG5

| V/Š | 50 | 60 | 70 | 80 | 90 | 100 | 110 | 120 | 130 | 140 | 150 | 160 | 170 | 180 | 190 | 200 | 210 | 220 |
|-------|--------|--------|--------|--------|--------|--------|--------|--------|--------|---------|---------|---------|---------|---------|---------|---------|---------|---------|
| 80 | 2672,- | 2936,- | 3223,- | 3577,- | 3908,- | 4217,- | 4504,- | 4901,- | 5277,- | 5498,- | 5939,- | 6072,- | 6579,- | 6844,- | 7352,- | 7882,- | 8235,- | 8633,- |
| 90 | 2782,- | 3091,- | 3466,- | 3798,- | 4107,- | 4416,- | 4791,- | 5144,- | 5520,- | 5740,- | 6182,- | 6314,- | 6866,- | 7131,- | 7617,- | 8147,- | 8567,- | 8964,- |
| 100 | 2981,- | 3290,- | 3665,- | 4018,- | 4305,- | 4637,- | 5012,- | 5431,- | 5763,- | 6027,- | 6447,- | 6624,- | 7153,- | 7396,- | 7926,- | 8412,- | 8854,- | 9339,- |
| 110 | 3135,- | 3466,- | 3864,- | 4217,- | 4570,- | 4835,- | 5255,- | 5674,- | 6050,- | 6270,- | 6712,- | 6911,- | 7463,- | 7705,- | 8213,- | 8655,- | 9185,- | 9715,- |
| 120 | 3290,- | 3643,- | 4040,- | 4416,- | 4791,- | 5056,- | 5475,- | 5939,- | 6292,- | 6535,- | 6955,- | 7242,- | 7772,- | 8015,- | 8544,- | 8920,- | 9472,- | 10046,- |
| 130 | 3488,- | 3820,- | 4195,- | 4637,- | 5012,- | 5277,- | 5696,- | 6182,- | 6557,- | 6800,- | 7264,- | 7551,- | 8081,- | 8324,- | 8831,- | 9185,- | 9825,- | 10465,- |
| 140 | 3687,- | 3996,- | 4327,- | 4835,- | 5255,- | 5475,- | 5939,- | 6425,- | 6800,- | 7087,- | 7529,- | 7904,- | 8412,- | 8655,- | 9185,- | 9516,- | 10156,- | 10796,- |
| 150 | 3842,- | 4151,- | 4482,- | 5012,- | 5453,- | 5674,- | 6160,- | 6668,- | 7065,- | 7374,- | 7816,- | 8235,- | 8743,- | 9008,- | 9538,- | 9869,- | 10509,- | 11172,- |
| 160 | 3908,- | 4261,- | 4659,- | 5144,- | 5652,- | 5895,- | 6381,- | 6889,- | 7330,- | 7661,- | 8125,- | 8611,- | 9096,- | 9383,- | 9891,- | 10222,- | 10863,- | 11503,- |
| 170 | 4018,- | 4394,- | 4813,- | 5321,- | 5873,- | 6094,- | 6646,- | 7131,- | 7573,- | 7948,- | 8434,- | 8964,- | 9405,- | 9759,- | 10244,- | 10598,- | 11238,- | 11878,- |
| 180 | 4107,- | 4504,- | 4946,- | 5475,- | 6072,- | 6314,- | 6866,- | 7352,- | 7860,- | 8213,- | 8743,- | 9361,- | 9781,- | 10090,- | 10620,- | 10951,- | 11591,- | 12232,- |
| 190 | 4261,- | 4659,- | 5100,- | 5630,- | 6270,- | 6535,- | 7087,- | 7573,- | 8103,- | 8522,- | 9052,- | 9737,- | 10134,- | 10465,- | 10995,- | 11304,- | 11945,- | 12607,- |
| 200 | 4327,- | 4791,- | 5277,- | 5763,- | 6491,- | 6734,- | 7330,- | 7816,- | 8346,- | 8787,- | 9361,- | 10068,- | 10487,- | 10819,- | 11326,- | 11680,- | 12320,- | 12960,- |
| 210 | 4438,- | 4901,- | 5431,- | 5939,- | 6668,- | 6933,- | 7551,- | 8037,- | 8611,- | 9096,- | 9648,- | 10443,- | 10841,- | 11216,- | 11724,- | 12055,- | 12717,- | 13380,- |
| 220 | 4526,- | 5034,- | 5564,- | 6094,- | 6844,- | 7153,- | 7794,- | 8279,- | 8854,- | 9361,- | 9980,- | 10774,- | 11216,- | 11591,- | 12099,- | 12452,- | 13137,- | 13843,- |
| 230 | 4725,- | 5211,- | 5718,- | 6248,- | 6999,- | 7352,- | 8015,- | 8522,- | 9141,- | 9626,- | 10267,- | 11106,- | 11569,- | 11989,- | 12519,- | 12872,- | 13578,- | 14285,- |
| 240 | 4857,- | 5343,- | 5895,- | 6381,- | 7176,- | 7551,- | 8235,- | 8743,- | 9383,- | 9935,- | 10598,- | 11437,- | 11922,- | 12364,- | 12938,- | 13313,- | 13998,- | 14704,- |
| 250 | 5012,- | 5498,- | 6050,- | 6557,- | 7330,- | 7772,- | 8500,- | 8964,- | 9626,- | 10200,- | 10885,- | 11790,- | 12298,- | 12739,- | 13335,- | 13755,- | 14462,- | 15146,- |
| XOPB1 | 261,- | 281,- | 321,- | 361,- | 401,- | 422,- | 442,- | 462,- | 482,- | 502,- | 522,- | 542,- | 562,- | 582,- | 602,- | 622,- | 642,- | 662,- |

Náhradní díly a doplňky:

| | obj. č. | délka (cm) | balení | DMC s DPH |
|------------------------------|---------|------------|--------|------------|
| Ovládací tyčky plisse (elox) | XZP2 | 100 | 1ks | 720,- Kč |
| | XZP3 | 150 | 1ks | 960,- Kč |
| | XZP4 | 200 | 1ks | 1 200,- Kč |
| | XZP6 | 300 | 1ks | 1 600,- Kč |

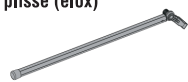

| | | | | |
|---|--|--|-----|---------|
| Plastový unášec plisse (šňurek) komplet | XZP151 | | 1ks | 39,- Kč |
| | Barevnosti: 312 šedá, 350 bílá, 356 černá, 505 bronz, 357 béžová | | | |

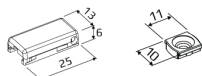

| | | | | |
|--|--------|--|------|---------|
| Držák plastového unášče na zasklívací lištu (1xL a 1xP) | XZP158 | | sada | 82,- Kč |
| Barevnosti: 312 šedá, 350 bílá, 356 černá, 505 bronz, 357 béžová | | | | |

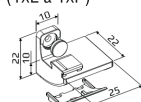

| | | | | |
|--|--------|--|-----|----------|
| Držák plastového unášče na stěnu (rám okna) plast | XZP156 | | 1ks | 121,- Kč |
| Barevnosti: 312 šedá, 350 bílá, 356 černá, 505 bronz, 357 béžová | | | | |

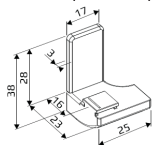

| | | | | |
|--|--------|--|-----|---------|
| Madlo | XZP169 | | 1ks | 22,- Kč |
| Barevnosti: 312 šedá, 350 bílá, 356 černá, 505 bronz, 357 béžová | | | | |

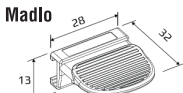

| | | | | |
|--|--------|------|-----|----------|
| Závěsný držák na rám okna pro klip XZP98 | XZP127 | bílý | 1ks | 102,- Kč |
| 62 - 90 mm 21 mm | | | | |



| | | | | |
|---|--------|------|-----|----------|
| Závěsný držák na rám okna pro unášec XZP151 | XZP126 | bílý | 1ks | 126,- Kč |
| 62 - 90 mm 21 mm | | | | |



| | | | | |
|------------------------------|--------------|--|-----|---------|
| Stěnový držák plisse (zinek) | XZP73K - 830 | | 1ks | 17,- Kč |
|------------------------------|--------------|--|-----|---------|

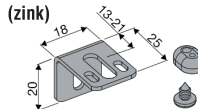

| | | | | |
|---|-----------------|--|-----|---------|
| Držák plisse klip | XZP98 - 830 | | 1ks | 22,- Kč |
| | XZP98 - barevný | | 1ks | 33,- Kč |
| Barevnosti: 830 zinek, 350 bílá, 356 černá, 505 bronz, 357 béžová | | | | |

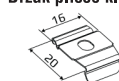

| | | | | |
|--|--------|--|-----|---------|
| Držák klipu na zasklívací lištu | XZP157 | | 1ks | 46,- Kč |
| Barevnosti: 312 šedá, 350 bílá, 356 černá, 505 bronz, 357 béžová | | | | |

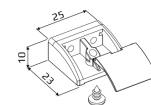

| | | | | |
|--|--------|--|-----|---------|
| Držák klipu na stěnu (rám okna) plast | XZP154 | | 1ks | 71,- Kč |
| Barevnosti: 312 šedá, 350 bílá, 356 černá, 505 bronz, 357 béžová | | | | |

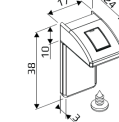

| | | | | |
|--|--------|--|-----|--------|
| Držák madla | XZP170 | | 1ks | 9,- Kč |
| Barevnosti: 312 šedá, 350 bílá, 356 černá, 505 bronz, 357 béžová | | | | |

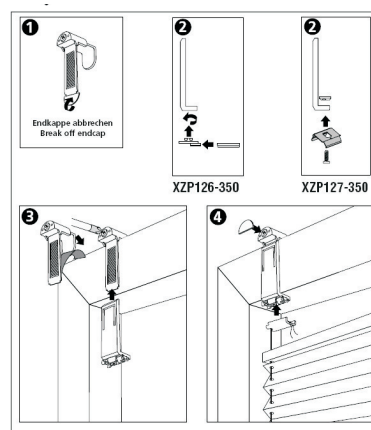



Objednávka PLISSE

Odběratel:

Dodavatel:

PRAKTIC s.r.o.
 Pištín 133
 tel: 387 983 071
 fax: 387 983 209
objednavky@practic.cz
www.practic.cz

datum:

zakázka č.:

zákazník:

sdělení:

| Pořice | TYP (příklad XPAB11) | Kusy | Barva | Písmeno kolece | látka | cenová skupina | Rozměry | | Rozměry pro šikminy | | Ovládání | | Barva profilu | | | Montáž | | | poznámka | | | | | |
|--------|-------------------------|------|-------|----------------|-------|----------------|-------------------|--|------------------------------------|-----------------------------------|--|---|---------------|---------------|-----------------------|--------|-------|---------------------|----------|------------------|--|--|--|--|
| | | | | | | | celková šíře (cm) | Celková výška (pro šikminy nejvyšší výška) | PRO ŠIKMINY celková výška nejnižší | PRO ŠIKMINY kontrolní šířka sklon | Provázek / Řetízek, když madlo tak nic | L | P | Bílá standard | Bezprátková barva RAL | Strop | Stěna | Na rám okna / dveří | | Zasklivačí lišta | | | | |
| 1 | | | | | | | | | | | | | | | | | | | | | | | | |
| 2 | | | | | | | | | | | | | | | | | | | | | | | | |
| 3 | | | | | | | | | | | | | | | | | | | | | | | | |
| 4 | | | | | | | | | | | | | | | | | | | | | | | | |
| 5 | | | | | | | | | | | | | | | | | | | | | | | | |
| 6 | | | | | | | | | | | | | | | | | | | | | | | | |
| 7 | | | | | | | | | | | | | | | | | | | | | | | | |
| 8 | | | | | | | | | | | | | | | | | | | | | | | | |

Pozor !!

Uvedené rozměry jsou vždy rozměry hotového výrobku
 Všechny výrobky sluneční ochrany jsou vyrobeny na míru a nemohou být vyměněny ani vráceny!

Nákres (Obrázek):

Ano
 Ne

Poznámka:

Pro atypické tvary, je naprosto nezbytný nákres!
 Rozměry jsou dle návodu na zaměření.

Formuláře v elektronické podobě jsou ke stažení na www.practic.cz